

PX155
PX156
PX157

MultiSystem Dimmer

INSTRUCTION
MANUAL



CONTENTS

1. General description	1
2. Safety conditions.....	1
3. Control elements description (based on PX155 model).....	2
4. Coupling diagrams.....	2
4.1. Model PX155.....	3
4.1.1. DMX-512 signal control.....	3
4.1.2. Potentiometers control.....	4
4.1.3. 0-10V signal control.....	5
4.1.4. Monostable buttons control.....	6
4.2. Model PX156.....	7
4.2.1. DMX-512 signal control.....	7
4.2.2. Potentiometers control.....	7
4.2.3. 0-10V signal control.....	8
4.2.4. Monostable buttons control.....	8
4.3. Model PX157.....	9
4.3.1. DMX-512 signal control.....	9
4.3.2. Potentiometers control.....	9
4.3.3. 0-10V signal control.....	10
4.3.4. Monostable buttons control.....	10
5. Displayed messages meaning.....	11
6. Dimmer programming.....	11
7. Programmable parameters.....	12
7.1. Digital input settings.....	12
7.1.1. Group parameters.....	12
7.1.2. Individual parameters.....	13
7.1.3. Temperature.....	13
7.1.4. Input control mode.....	13
7.1.5. Scenes and chasers programming.....	13

7.2. Analog input settings.....	14
7.2.1. Group parameters.....	14
7.2.2. Individual parameters.....	15
7.2.3. Temperature.....	15
7.2.4. Output mode.....	15
7.2.5. Function diagrams for external button control.....	16
7.2.5.1. Function one.....	16
7.2.5.2. Function two.....	16
7.2.5.3. Function three.....	17
7.2.5.4. Function four.....	17
7.2.5.5. Function five.....	17
8. Menu scheme for digital input.....	19
9. Menu scheme for analog input.....	20
10. Dimmer access lock.....	20
10.1. Switching the access lock on.....	21
10.2. Switching the access lock off.....	21
11. Notes.....	22
12. Technical specification.....	22
13. Declaration of conformity.....	23

Manufacturer reserves the right to make modifications in order to improve device operation.

<i>PXM s.c.</i>	<i>tel.: (+48 12) 626 46 92</i>
<i>ul. Przemysłowa 12</i>	<i>fax: (+48 12) 626 46 94</i>
<i>30-701 Kraków</i>	<i>E-mail: info@pxm.pl</i>
<i>POLAND</i>	<i>Internet: www.pxm.pl</i>

1. GENERAL DESCRIPTION

PX155, PX156 and PX157 are professional digital dimmers of powers 4 x 600W, 2 x 1200W and 1 x 2300W respectively, intended for DIN rail mounting in electrical switching stations. Powered with one phase. Allow to control four, two or one independent circuits of 0.6 / 1.2 / 2.3kW loads each.

The module is equipped with multi-type control inputs, that enable dimmer control with digital DMX-512 signal or analog signals - 0-10V or external monostable buttons.

Advanced electronics allows to set the DMX addresses for each channel at will, select one of eight control characteristics (linear, inverted linear, logarithmic, exponential, switched on/off and 3 characteristics for neon lamps control*), set ACL level (input voltage level in a range from 50 to 230V, exact to 1V), set bulbs filaments' preheat (0 - 10%) and choose the dimmer reaction to DMX signal interruption or fading (off, full on, slow dimming, last control value, one of three scenes or one of two chasers).

Built-in "soft-start"**, "soft-on"*** and "even-off"**** circuits ensure reliable dimmer operation even in the most adverse conditions and direct zero cross-over detection ensures a high noise resistance.

Casing for DIN rail mounting, 105 mm wide.

2. SAFETY CONDITIONS

Px155, PX156 and PX157 dimmers are powered directly from standard 230V grid, what can cause electric shock when safety rules are not observed. Therefore it is necessary to observe the following :

1. Installation, particularly power connection, should be performed by a person holding the appropriate qualifications, according to the description in the instruction manual.
2. Dimmers can be connected to socket which has protecting installation - separate PE strand - in working order only (3-strand grid).
3. All the conductors should be protected against mechanical and thermal damage.
4. In the event of damaging any conductor, it should be replaced with a conductor of the same technical data and attestations.
5. The external devices can be connected to the dimmer with 3-strand 1.5 mm² minimum cross-section area only.
6. Each receiver has to be powered with a separate cable.
7. Dimmer can be installed in closed electrical switching stations only, with restricted access for people who does not handle proper qualifications in 230V supplied devices maintenance.
8. Power input must to be protected with an external residual current breaker with overload of 25A rated current and C-type characteristic.
9. After the installation is completed, check the neutralization efficacy of all powered devices.
10. All repairs demanding casing opening should be made with cut off power supply.
11. The device should be strictly protected against water and other liquids.
12. All sudden shocks, particularly dropping, should be avoided.
13. Device with damaged (bent) casing should not be connected to the mains.

14. The device cannot be turned on in places with humidity exceeding 90%.
15. The device cannot be used in places with temperature lower than 2°C or higher than 40°C.
16. Clean with damp duster only - dimmer has to be cut off the power supply.

ATTENTION!!!

1. Improper connection of the protective wire (yellow-green strand) can cause electric shock.
2. Improper connection of the neutral wire (blue strand) automatically switches the dimmer off and activates an acoustic alarm.
3. The dimmer can control resistive and inductive circuits (loads) only.
The dimmer cannot be used to control the electronic transformers, electronic ballasts for fluorescent lamps and other devices that have electronic circuits, unless the producer distinctly states so.

3. DIMMER ELEMENTS' DESCRIPTION

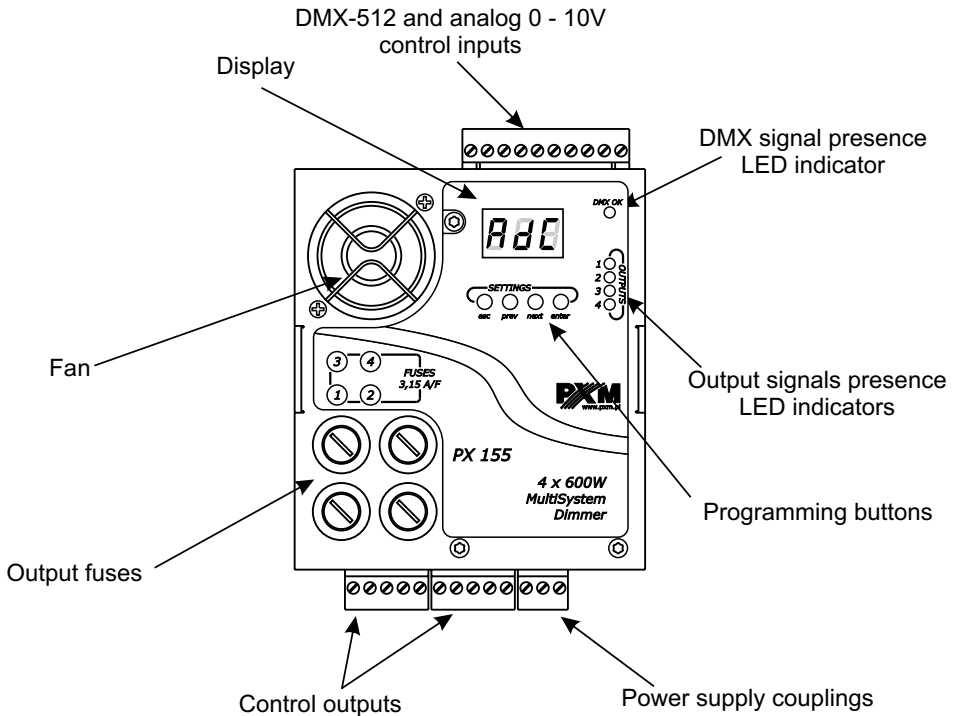

4. CONNECTIONS' SCHEMES

MultiSystem Dimmer must be connected to the DMX line in series. That means, the control cable must be driven to the DMX coupling of the dimmer, and then driven out from the same coupling (refer to the scheme below) to the next DMX-512 signal receivers. When MultiSystem Dimmer is installed as the last device in a DMX line, a terminator (110 Ohm resistor) must be connected to "DMX+" and "DMX-" terminals.

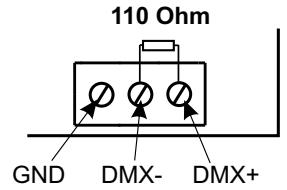
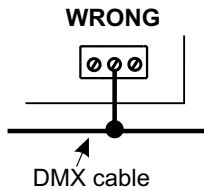
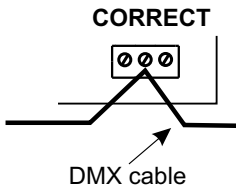

In addition, when, instead of potentiometers, the monostable button is to be applied, it must be connected to "+10V OUT" and "0 - 10V IN" inputs.

4.1. MODEL PX155

4.1.1. DMX-512 SIGNAL CONTROL

REFLECTORS

4 x 600W max.

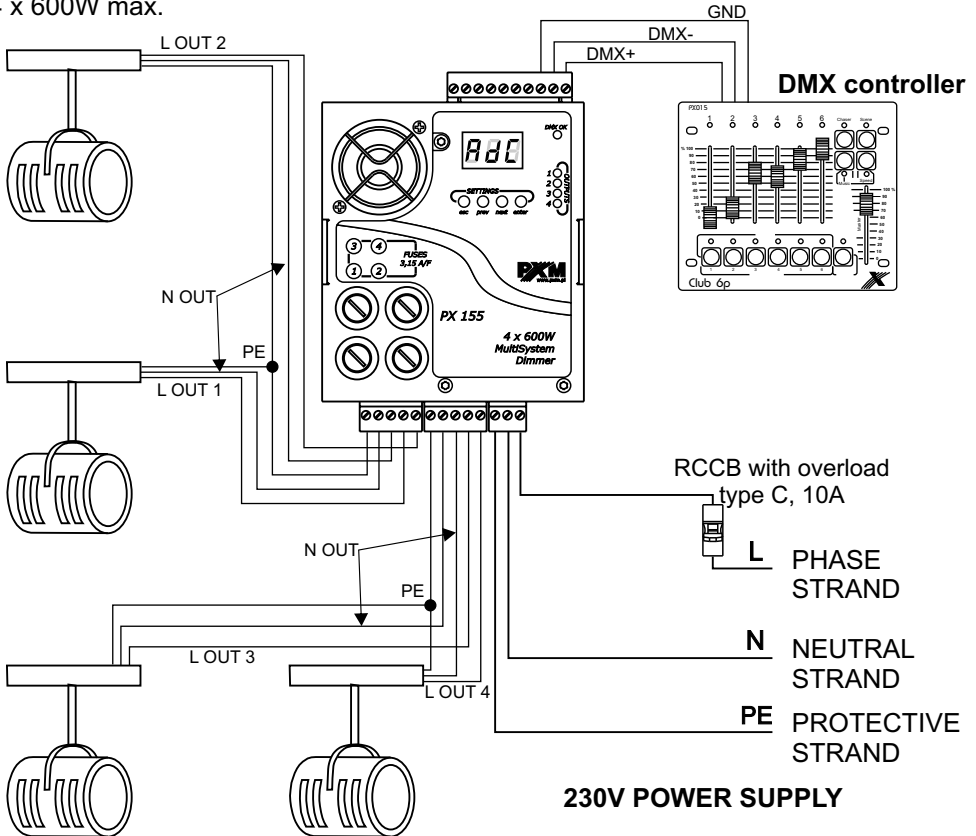

4.1.2. POTENTIOMETERS CONTROL

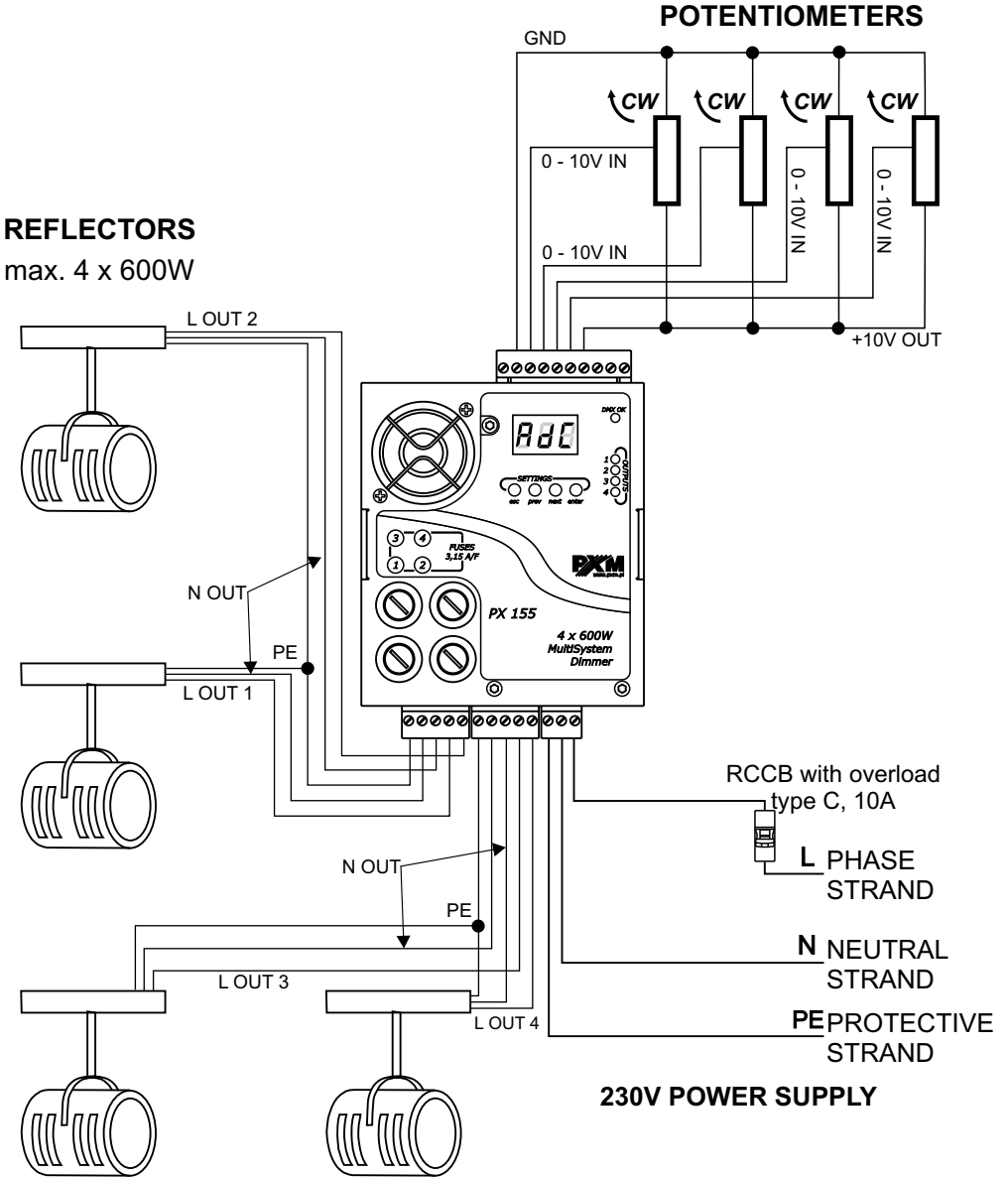

4.1.3. 0 - 10V CONTROL

REFLECTORS

max. 4 x 600W

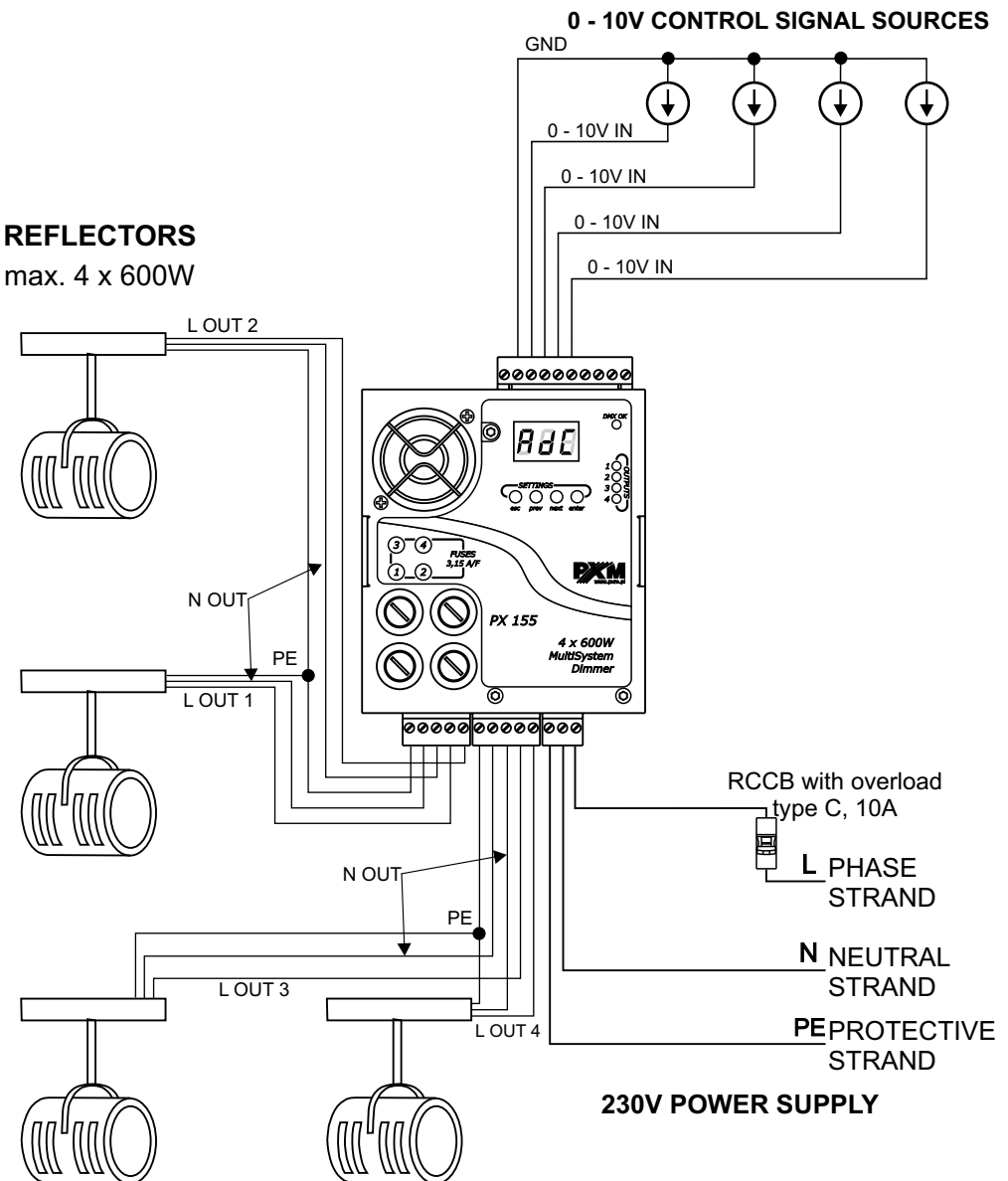

4.1.4. MONOSTABLE BUTTONS CONTROL

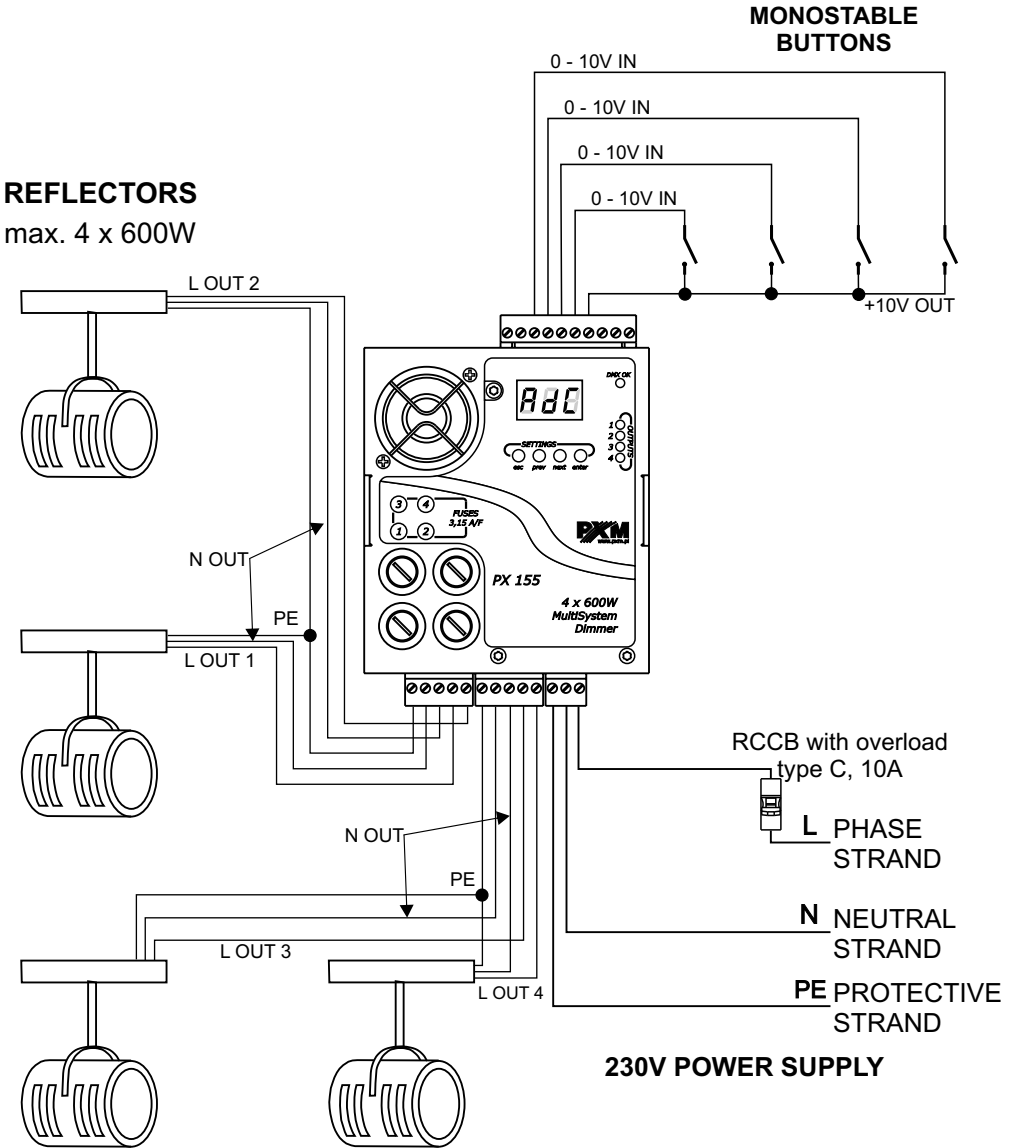

4.2. MODEL PX156

4.2.1. DMX-512 SIGNAL CONTROL

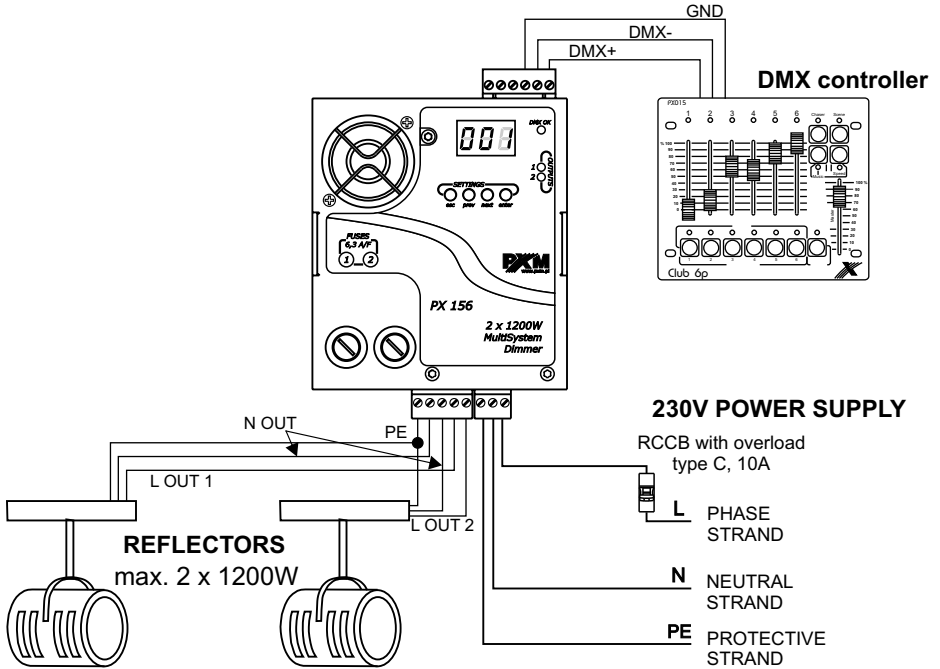

4.2.2. POTENTIOMETERS CONTROL

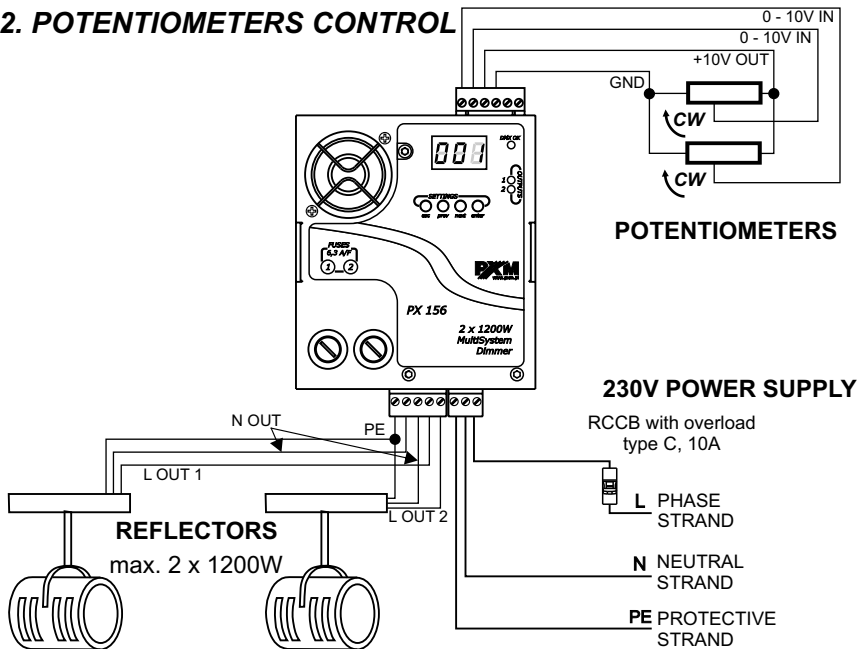

4.2.3. 0 - 10V SIGNAL CONTROL

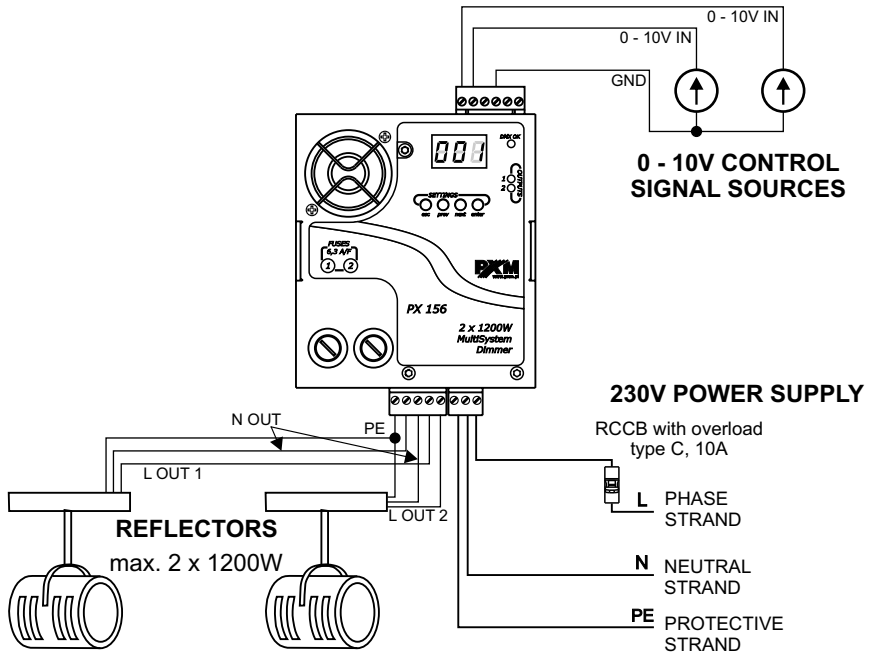

4.2.4. MONOSTABLE BUTTONS CONTROL

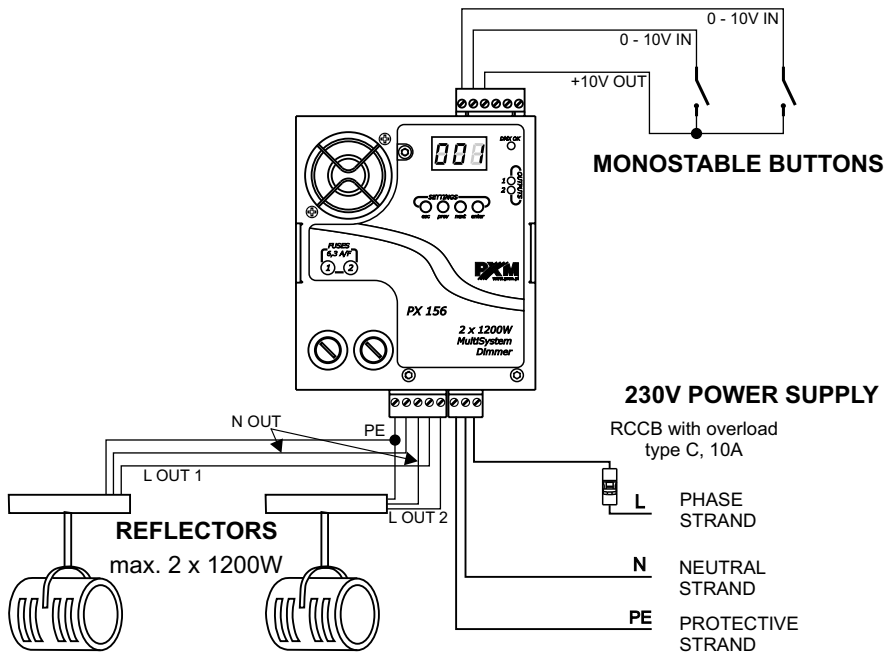

4.3. MODEL PX157

4.3.1. DMX-512 SIGNAL CONTROL

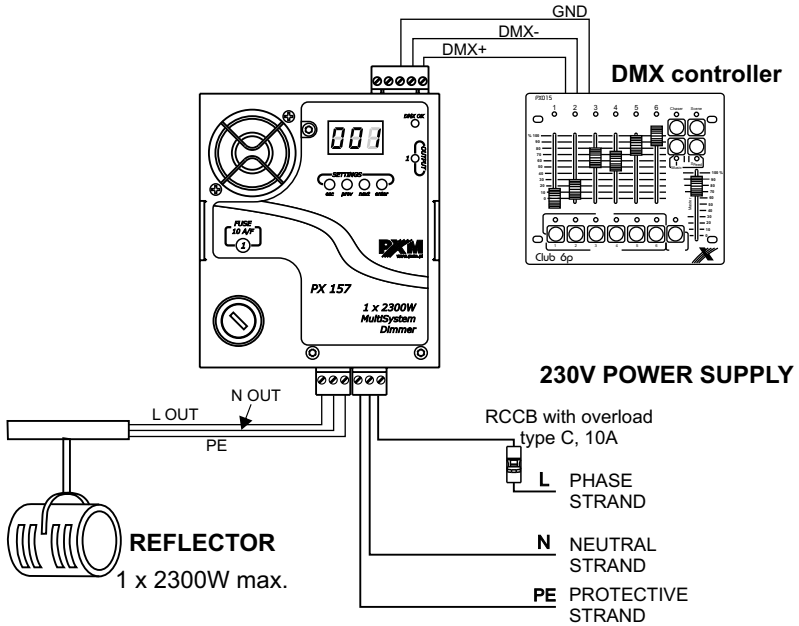

4.3.2. POTENTIOMETER CONTROL

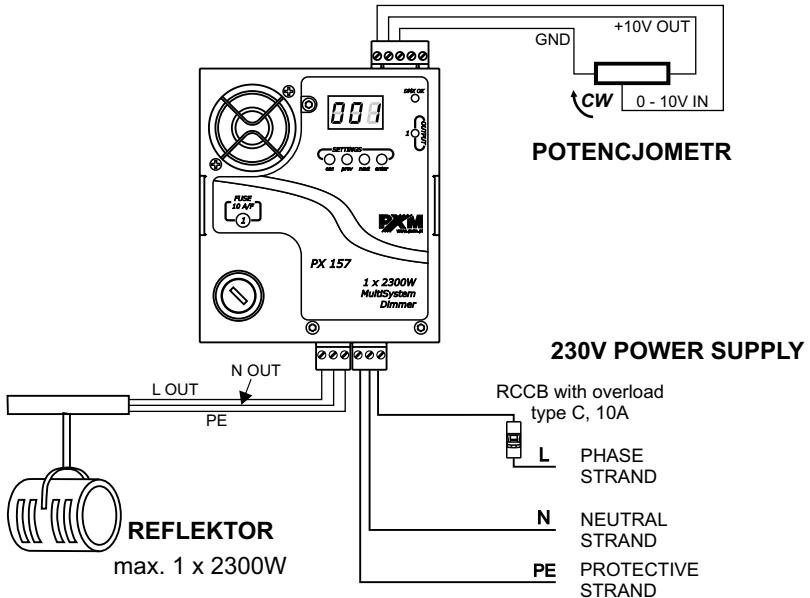



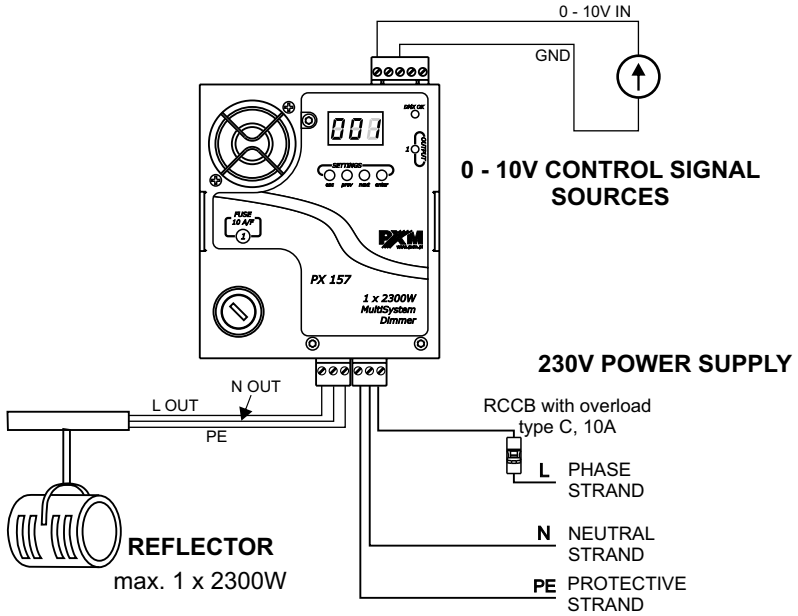



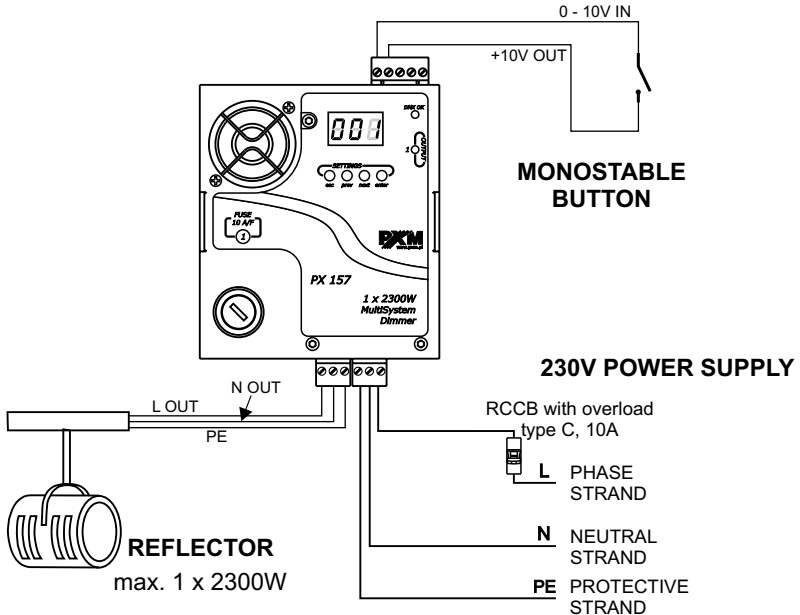



4.3.3. 0 - 10V SIGNAL CONTROL









4.3.4. MONOSTABLE BUTTON CONTROL



5. DISPLAYED MESSAGES MEANING

	No DMX signal: slow (20 seconds approximately) dimming of all the outputs.		No DMX signal: recently controlled values maintaining.
	Minimal brightness of a particular channel shown in percentage (%).		Individual programming parameters.
	Maximal brightness of a particular channel shown in percentage (%).		Characteristic: linear.
	Limit. Output voltage limitation in a range from 50 to 230V.		Characteristic: logarithmic.
	DMX address. Selected in a range from 1 - 509 (at the 509 setting channel 4 has 512 address).		Characteristic: inverted.
	Group parameters.		nE1 - nE3. Characteristics: for neon lamps control.
	C01 - C04, number of the edited channel.		No signal. Device reaction to DMX signal absence or interruption (9 possibilities to choose from).
	Built-in factory chaser (in addition - reaction to DMX signal absence or interruption).		No signal: all outputs controlled at 100 %.
	Programmable chaser (in addition - reaction to DMX signal absence or interruption).		No signal: all outputs turned off.
	Characteristics. 6 different characteristics to choose from.		Preheat - bulb's filaments preheating. Set in a range from 0 to 10 %.
	Scenes and chasers programming.		Sc1 - Sc3 - programmable scenes (set also in case of DMX signal absence or interruption).
	Characteristic: exponential.		Chaser speed in a range from 001 to 032.
	F01 - F04 - numbers of the edited scenes.		Characteristic: switchable.
	XFade switching on/off (for scene smooth changing).		Input mode switching (digital/analog).
	Analog input 0 - 10V.		External button control.
	Control functions for external button.		Control function executed with external button no. 1.
	Brightness rising time for button control.		Maximum brightness duration time for button control.
	Dimmer internal temperature.		Temperature sensor fail - contact service for repair.
	Analog control (0-10V or switches)		Last step
	Dimmer wake up after power supply connection.		

6. DIMMER PROGRAMMING

After turning the device on, software version is shortly displayed. During the device normal operation the display shows DMX address or displays  lettering, meaning analog control mode. Pressing ESCAPE during normal operation will test the display - all the segments should get ON state. Press ENTER to switch to the main menu, the display will show . Press PREVIOUS or NEXT to select programming menu (, , , ), and then press ENTER to confirm your selection.

7. PROGRAMMABLE PARAMETERS

The parameters you can programm for the dimmer include:

1. Group parameters - **ALL** :

Settings are the same for all the channels. For DMX address setting it means that address displayed is the address of the first channel. The addresses of subsequent channels will be set automatically. Programming DMX address in this menu deletes the previously programmed individual addressing.

2. Individual parameters - **Ind** :

Each channel may be set with individual parameters, including individual DMX addressing. The same address may be set to more then only one channel.

As mentioned above the group DMX address programming deletes the previous individual settings.

3. Dimmer temperature - **DEC**

The function to check out the internal dimmer temperature.

4. Analog/digital mode of operation switching - **ADL**

The function to switch between digital control mode (DMX) or analog control (0 - 10V signal or monostable external button).

5. Scenes and chasers programming - **DEF** - active only with the digital control mode (so the parameter **ADL** set to **OFF**):

The function allows:

- 3 scenes programming,
- 4 user-defined chaser steps with speed and fading options programming,
- speed and fading of built-in chaser.

7.1. DIGITAL INPUT SETTINGS

Digital input (so controlling the dimmer with DMX-512 signal) is active when parameter **ADL** is set to **OFF** .

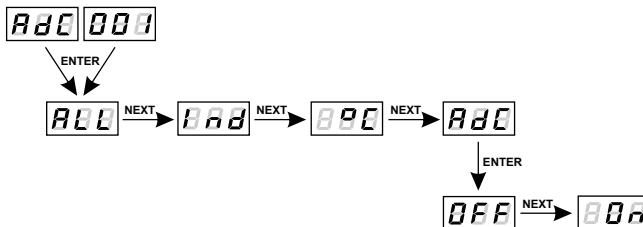

7.1.1. GROUP PARAMETERS

1. **ADL** - DMX address from the range 1 to 509 (setting 509 as the address for the first channel means automatically address 512 for the fourth dimmer channel).
2. **DEF** - charasteric. There are 8 options to choose from:
 - LIN** - linear,

- SP** - switchable,
 - INV** - inverted,
 - LOG** - logarithmic,
 - EXP** - exponential,
 - NE1** ... **NE3** - for neon lamps control*.
3. **ACL** - limit. Limits the output voltage in the range from 50 - 230 V.
 4. **PFE** - preheat. Heating up the bulb filaments. Set in the range from 0 - 10 %.
 5. **FSO** - dimmer wake up after power supply connection.
 6. **RS** - no signal. Precise the dimmer reaction to DMX signal interruption. There are 9 options to choose from:
 - ON** - turning all outputs on at 100%,
 - OFF** - turning all outputs off,
 - HLd** - the last received value is held
 - SO** - slow output switching off (about 20 seconds),
 - S1** ... **S3** - programmable scenes,
 - CF** - built-in chaser,
 - CR** - user-defined chaser.

7.1.2. INDIVIDUAL PARAMETERS

1. **ADR** - DMX address from the range 1 to 512.
2. **CHR** - characteristic. There are 8 options to choose from:
 - LN** - linear,
 - SP** - switchable,
 - INV** - inverted,
 - LOG** - logarithmic
 - EXP** - exponential,
 - NE1** ... **NE3** - for neon lamps control*.
3. **ACL** - limit. Limits the output voltage in the range from 50 - 230 V.

7.1.3. TEMPERATURE

PTC - this parameter allows to check the dimmer internal temperature in the range -40 to +125°C. CAUTION: Lettering **EFH** means sensor failure. so service is necessary.

7.1.4. INPUT CONTROL MODE

ADM - switching between default digital control mode (DMX-512, setting **OFF**) and analog mode (0 - 10V control signal or external button - setting **BDN**).

7.1.5. SCENES AND CHASERS PROGRAMMING

1. **S1** ... **S3** - scenes programming:
 - C01** ... **C02** - edited channel number,
 - B00** ... **B00** - channel brightness in percentage %.
2. **CR** - user-defined chaser:
 - F01** ... **F00** - editable pattern numbers,

001 ... **004** - edited channel number,

000 ... **100** - channel brightness in percentage %,

LEN - chaser step number (1 to 8),

SPD - chaser speed from 1 (255 seconds) to 32 (0,1 second),
FAD - scenes fading function switching on or off.

3. **EFF** - built-in chaser:

SPD - chaser speed from 1 (255 seconds) to 32 (0,1 second),

FAD - scenes fading function switching on or off.

7.2. ANALOG INPUT SETTINGS

Analog input for smooth 0 - 10V control or monostable button control is active with the parameter

ADC set to **001**.

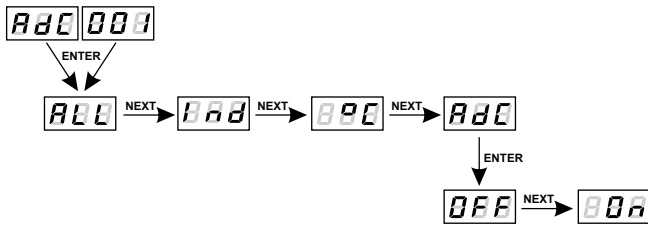

7.2.1. GROUP PARAMETERS

1. **AIN** - detailed settings for analog control input:

ANL - 0 - 10V control signal (max brightness at 10V), realised with potentiometer or external voltage source,

BUN - settings for external monostable button control:

FUN - 5 functions to choose from (look diagrams section 7.2.5),

RIS - brightness rising time to maximum allowed by output **ACL** voltage
- from 0 (immediately) to 255 seconds,

DRS - duration time from 0 to 255 seconds.

2. **CFR** - characteristic. There are 8 options to choose from:

LIN - linear,

SP2 - switchable,

INV - inverted,

LRU - logarithmic

EXP - exponential

NE1 ... **NE3** - for neon lamps control*.

3. **ACL** - limit. Limits the output voltage in the range from 50 - 230 V.

4. **PFE** - preheat. Heating up the bulb filaments. Set in the range from 0 - 10 %.

5. **FSA** - dimmer wake up after power supply connection.

7.2.2. INDIVIDUAL PARAMETERS

1. **A1n** - analog control input settings for each channel:
 - A0L** - 0 - 10V control signal (max brightness at 10V), realised with potentiometer or external voltage source,,
 - b1n** - settings for monostable external button:
 - F0n** - 5 functions to choose from (look diagrams section 7.2.5),
 - F1S** - brightness rising time to maximum allowed by output **A0L** voltage - from 0 (immediately) to 255 seconds
 - L0S** - maximum brightness duration time from 0 to 255 seconds.
2. **E0P** - characteristic. There are 8 options to choose from:
 - L0n** - linear,
 - S0P** - switchable,
 - I0n** - inverted,
 - L0U** - logarithmic
 - E0P** - exponential
 - n01** ... **n03** - for neon lamps control*.
3. **A0L** - limit. Limits the output voltage in the range from 50 - 230 V.

7.2.3. TEMPERATURE

B0E - this parameter allows to check the dimmer internal temperature in the range -40 to +125°C. CAUTION: Lettering **E0H** means sensor failure. so service is necessary.

7.2.4. INPUT MODE

A0E - switching between default digital control mode (DMX-512, setting **0FF**) and analog mode (0 - 10V control signal or external button - setting **00n**).

7.2.5. FUNCTION DIAGRAMS FOR EXTERNAL BUTTON CONTROL

7.2.5.1. Function one

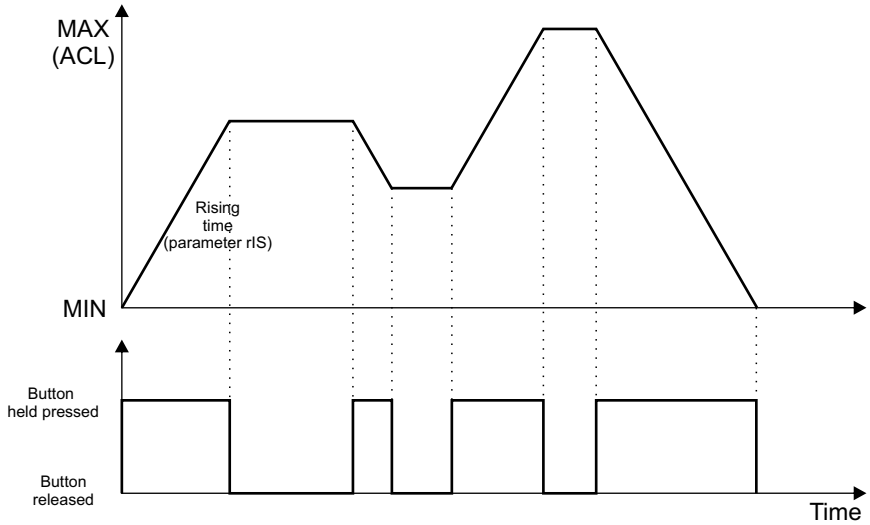

7.2.5.2. Function two

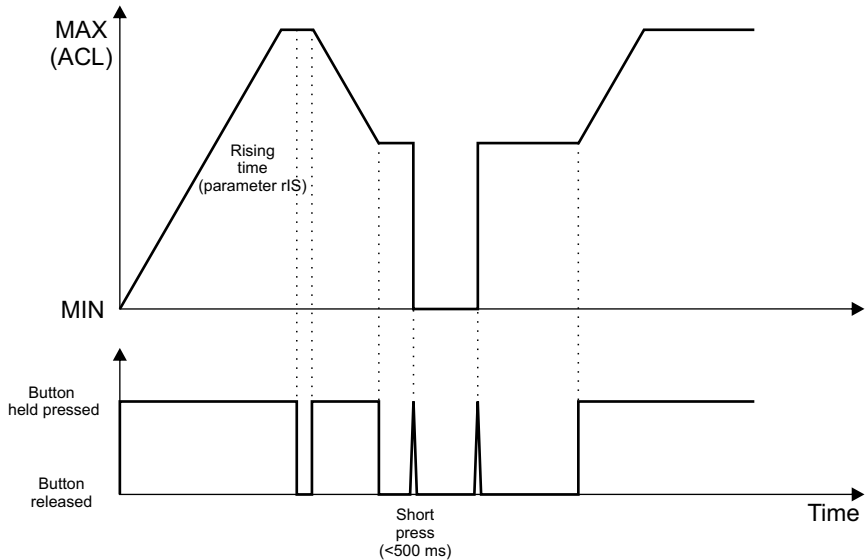

7.2.5.3. Function three

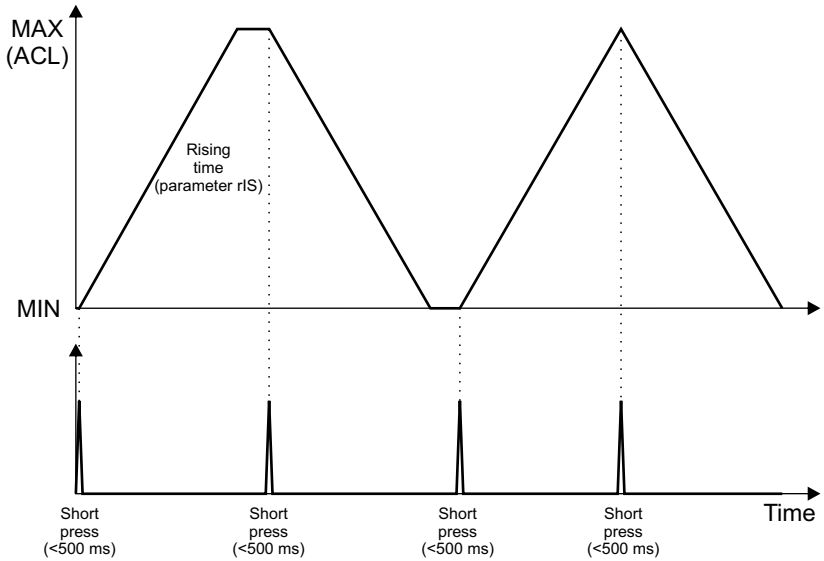

7.2.5.4. Function four

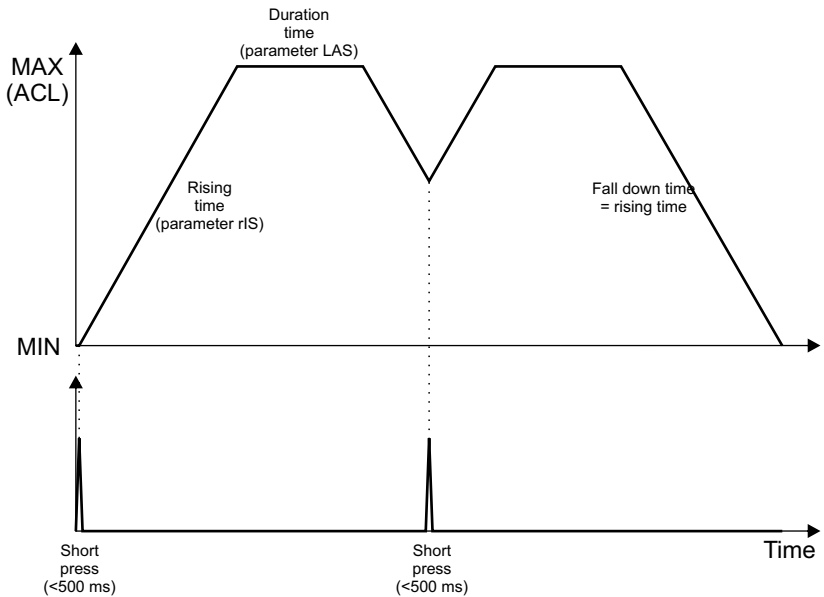

Each short button pressing when function realises **ERS** parameter resets the parameter counting time to 0. The parameter **ERS** is active only for function four and is ignored by other dimmer functions.

7.2.5.5. Function five

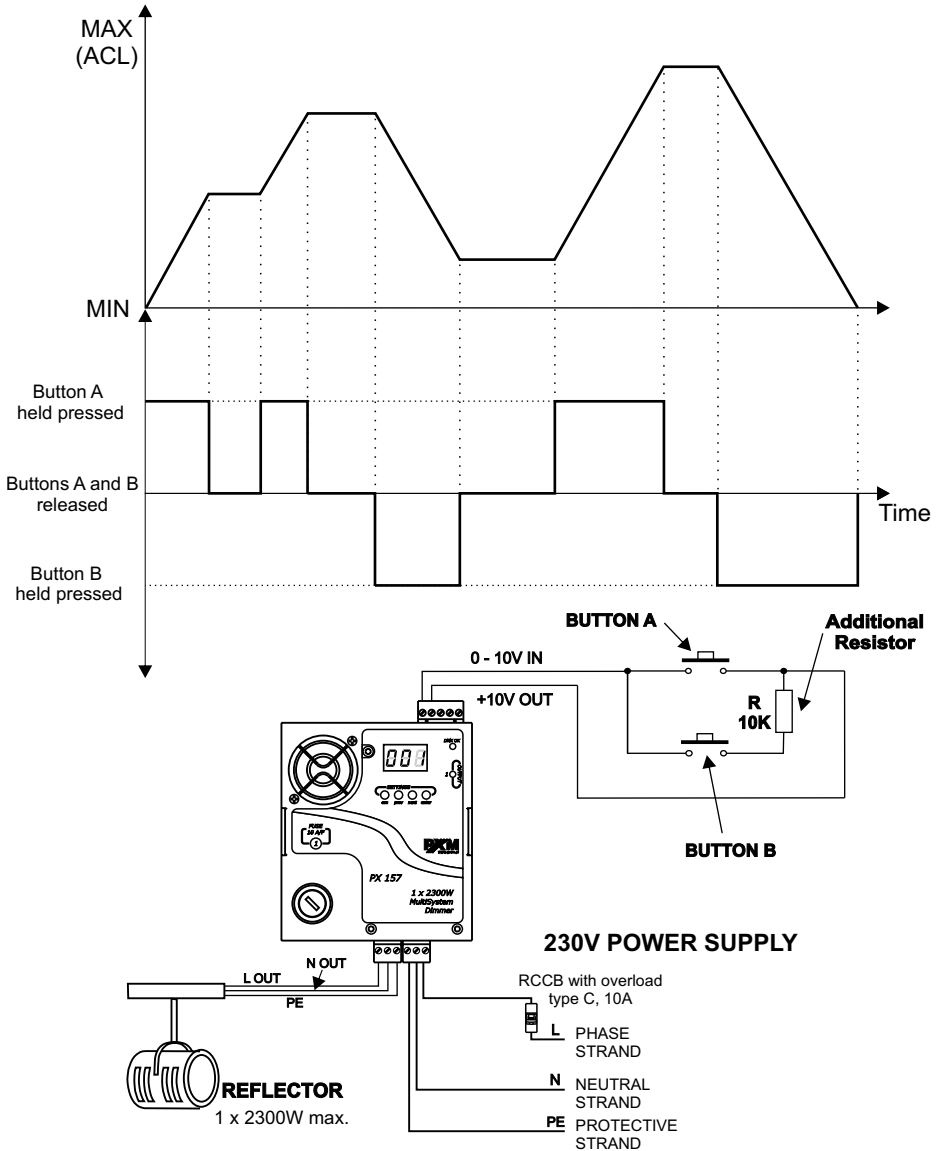

Pressing and holding the external button "A" causes rise of the brightness. Once it is released the brightness stops to increase. Pressing and holding the external button "B" leads to the brightness fall down. After releasing the button "B" brightness will remain at the same level as at the time of its release.

ATTENTION!!!

To use this function additional resistor should be installed before external button "B" (as in the schematic diagram above).

8. MENU SCHEME FOR DIGITAL INPUT

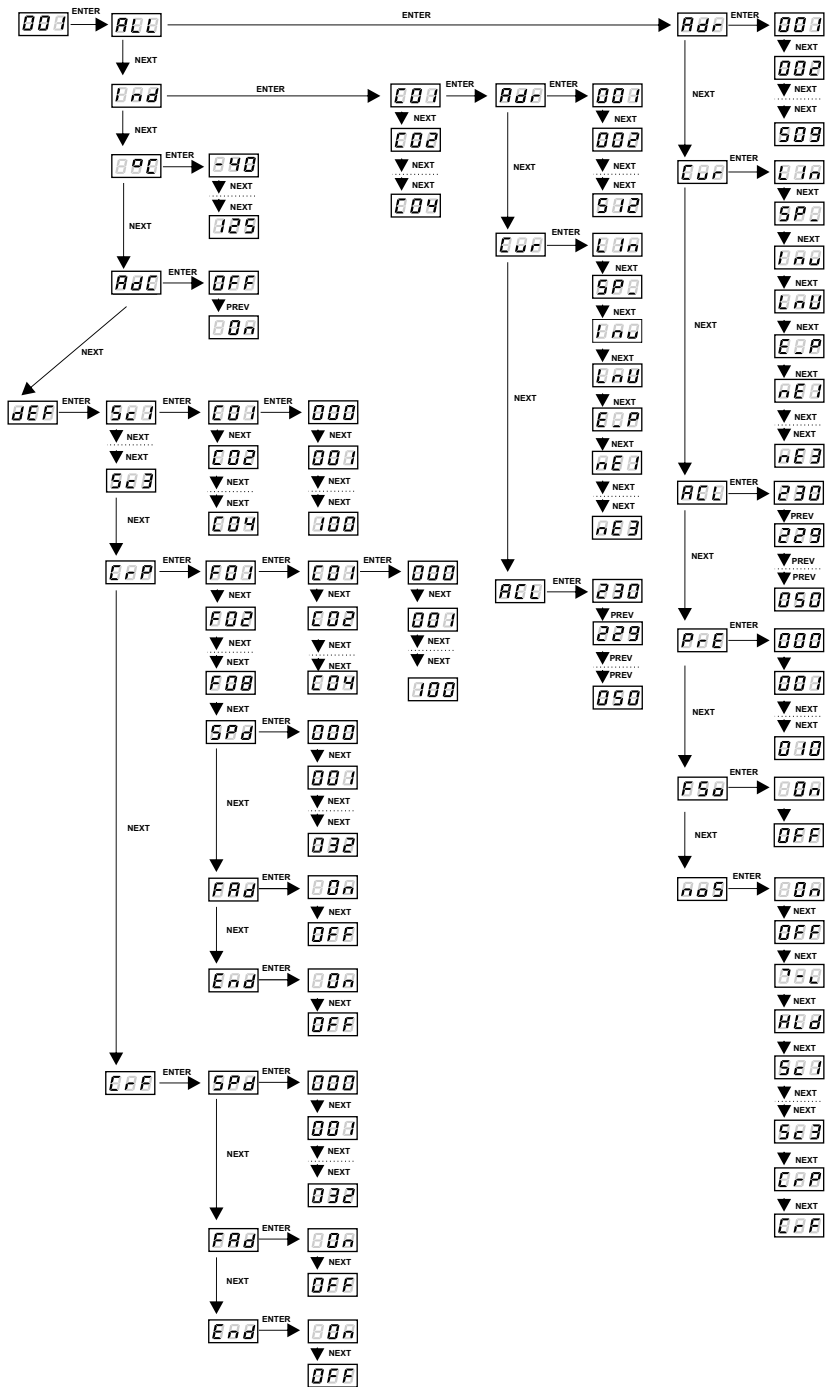

9. MENU SCHEME FOR ANALOG INPUT

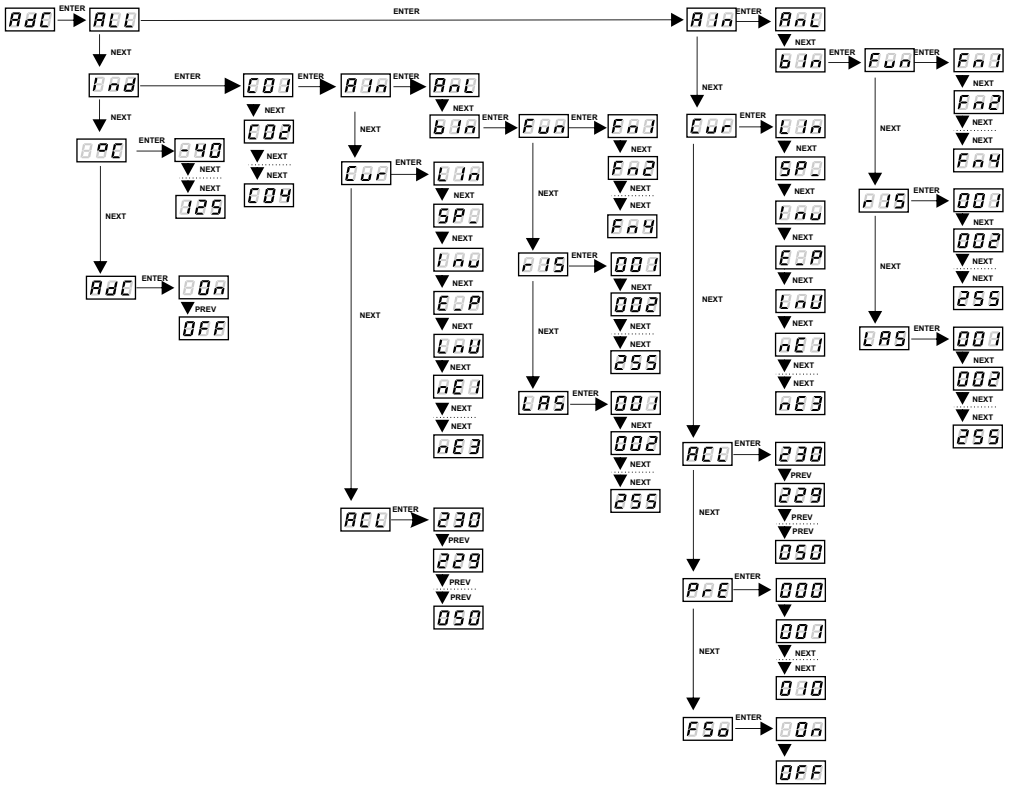

NOTES:

1. ENTER enters the menu sublevels and confirms the values set during programming.
2. CANCEL exits the currently programmed parameter without saving changes or returns to the previous menu level.
3. NEXT scrolls the menu forwards or increases the values set.
4. PREV scrolls the menu backwards or decreases the values set.
5. 001 means channel 1.

10. DIMMER ACCESS LOCK

According to expanded possibilities of dimmer parameters settings there is option to code programming effects (programmer-defined number from range 1 to 255). Such situation other users can only read defined parameters without possibility of modification. With the parameters coded also function. DEF.. is not displayed.

10.1. SWITCHING THE ACCESS LOCK ON

1. Press CANCEL enough times to leave dimmer programming mode - the display will show finally DMX address. Then press and hold CANCEL and press NEXT - the display will answer with **PR5** lettering. Release CANCEL key.
2. Press ENTER. The display will show **ERR**. (CAUTION!! If **d5b** appears dimmer is already code protected - see point 10.2).
3. Once again press ENTER and choose the password with NEXT/PREV keys. Confirm decision with ENTER.
4. The dimmer is code protected. It will automatically terminate locking procedure and return to programmed operation.

10.2. SWITCHING THE ACCESS LOCK OFF

1. Press CANCEL enough times to leave dimmer programming mode - the display will show finally DMX address. Then press and hold CANCEL and press NEXT - the display will answer with **PR5** lettering. Release CANCEL key.
2. Press ENTER. The display will show **d5b** (CAUTION!! If **ERR** appears dimmer is not code protected - see point 10.1).
3. Once again press ENTER and the display will show **123** Set user-defined password with NEXT/PREV keys. Confirm correct number with ENTER.
4. The dimmer password is removed and all programmable parameters are unlocked. Dimmer will automatically return to standard operation.

ATTENTION!!

Confirming the wrong password will display **ERR**. It is necessary to start unlocking procedure from beginning. The third time wrong password setting will lock the dimmer permanently, displaying **LCE**. The telephone contact to service is necessary to reset the password.

11. NOTES

Explanation of terms with asterisk (*):

* neon lamps control characteristics - each characteristic **RE1**, **RE2** and **RE3** is dedicated to inductive load control as for neon lamp transformers. Differences between characteristics are only in lamp switching level, so the start brightness of the lamp. The suitable characteristic should be decided depending on user light installation;

** "soft-start" - soft dimmer reaction to power supply connection;

*** "soft-on" - slow output activation important for inductive loads;

**** "even-off" - protection against controlled transformer core saturation.

12. TECHNICAL SPECIFICATION

- control input - DMX-512 or 0 - 10V or monostable buttons
- input current for 0 - 10V control - 1mA
- output control load +10V out - 10mA
- resistive output load
 - dimmer PX155 - 4 x 600W
 - PX156 - 2 x 1200W
 - PX157 - 1 x 2300W
- inductive output load
 - dimmer PX155 - 4 x 300VA
 - PX156 - 2 x 600VA
 - PX157 - 1 x 1200VA
- output protection - fast fuses
 - dimmer PX155 - 4 x 3,15A
 - PX156 - 2 x 6,3A
 - PX157 - 1 x 10A
- thermal protection - depending on internal dimmer temperature:
 - 60°C - electronic controlled fan starts operation,
 - 90°C - 20% power reduction,
 - 100°C - automatic dimmer switch off
- power supply - 230V / 50Hz
- min. current consumption - 13mA
- max. current consumption - 10A
- weight - 1,3 kg
- dimensions:
 - width - 105 mm
 - height - 132 mm
 - depth - 96 mm

Dimmers are leading edge devices - the control is made with rising edge and they can handle the following types of loads:

R - Compatible with R-type loads (resistive)

RL - compatible with the type R and L loads (resistive and inductive)





ul. Przemysłowa 12
30-701 Kraków, Poland

tel: +48 12 626 46 92
fax: +48 12 626 46 94

e-mail: info@pxm.pl
http://www.pxm.pl

DECLARATION OF CONFORMITY

according to guide lines 73/23/EWG and 89/336/EWG

Name of producer: PXM s.c.

Address of producer: ul. Przemysłowa 12
30-701 Kraków

declares that the product:

Name of product: **MultiSystem Dimmer**
4 x 600W / 2 x 1200W / 1 x 2300W

Type: **PX155 / PX156 / Px157**

answers the following product specifications:

LVD: PN-EN 60065

EMC: PN-EN 55014

Additional informations:

1. The dimmer PE terminal must be connected to efficient ground installation equipped with the residual-current circuit breaker.
2. The dimmer can be installed in the closed switching stations only.

PXM S.C.
Danuta i Marek Żupnik
30-701 Kraków, ul. Przemysłowa 12
NIP 677-002-54-53

Kraków, 01.09.2008

Marek Żupnik M. Sc. Eng.